

USER MANUAL

This product uses a high-performance Hisilicon HI3556V200 chipset that supports high definition videos, dynamic images seamlessly. Support real full HD video 2K resolution for the front camera that can shoot 2560 pixels horizontally and 1440 pixels vertically at 30 frames per seconds and 1080p rear camera. Capture more details with 170° Ultra wide-angle front camera capturing the license plates, road signs more clearly and monitors all directions reducing the blind spots.

View dashboard camera recordings and manage car dash camera settings on your iOS and Android devices with built-in WIFI. By using the RoadCam App, you can download your recorded full HD quality videos directly to your smartphone and share these on social media easily with friends and family. This new Elinz dash camera is equipped with a built-in supercapacitor, which is much more durable and safer than normal battery

Please read this manual carefully before using. We hope that our products can meet your needs and provide a long-term service to you.

Disclaimer:

1. Please read the set-up and usage instructions carefully before operation.
2. You should not set/install this dash camera at a place that would obstruct or reduce a driver's view. Make sure your usage complies with pertinent vehicle codes of your state, province, territory or country.
3. You should post the required notices of recordation to occupants inside the vehicle, if voices or other information/signal pertaining to in-vehicle activities will be recorded.
4. You should not change the dash cam's setting or mode of operation when the vehicle is in motion.
5. You should not leave the dash cam in a visible spot when no one is inside the vehicle, to avoid attracting break-ins to steal the unit or other property.
6. You should avoid extended exposure of the dash cam to direct sunlight or extreme temperatures (either high or low temperature) which tend to degrade or damage the unit and its normal functionality.
7. You should examine, check and verify the dash cam at least every 6 months, including the memory card, to ensure the video reception and recording are working properly. For each use, you should verify that the dash cam unit, the visible lights and the audible sounds are working normally. If there are signs of non-operation or malfunction, you should immediately seek to replace the product and check to see if the product is covered under any applicable warranty.
8. The dash cam unit may have additional functionality, such as transmission and recordation of audible or other identification information. If you have privacy concerns about these functions, make sure you follow the instruction to disable these functions.
9. You should use the dash cam unit in the way it is intended. You should not use the dash cam unit in a way that would be illegal or that tends to physically damage the unit, or tend to cause danger to the safe operation of the vehicle or the occupants.
10. THIS DEVICE SHOULD NOT BE ADJUSTED BY THE DRIVER WHILE DRIVING.

Product management:

- **Do not expose the product to direct sunlight or intense light.** The lens or internal circuitry may fail otherwise
- **Do not apply excessive force when pressing the buttons.** Doing so may damage the buttons
- **Do not use chemical cleaners or solvents to clean the product.** Doing so may damage plastic components of the product. Clean the product using a clean, soft, and dry fabric.
- **Do not disassemble the product or subject the product to impact.** Doing so may damage the product. Unauthorized disassembly of the product voids the product warranty
- **Handle with care.** If you drop, mishandle, or expose the product to external shocks, it may cause damage and/or result in the malfunction of the product.
- Do not attempt to insert foreign objects into the device
- **Avoid excessive humidity and do not allow any water to enter the product.** Electronic components inside the product may fail if exposed to humidity or water.
- **Use the product at a temperature between 14°F and 140°F (-10°C to 60°C) and store the product at a temperature between -4°F and 158°F (-20°C to 70°C).** The product may not function as designed and some permanent physical damages may result if it is operated or stored out of the specified temperature ranges. Such damages are not covered by the warranty
- **This device is intended to be used inside the vehicle only.** Install this device in a location where it has unobstructed view of the road but does not interfere with the driver's view. Please check your local and regional law before mounting to windshield.

Product Overview

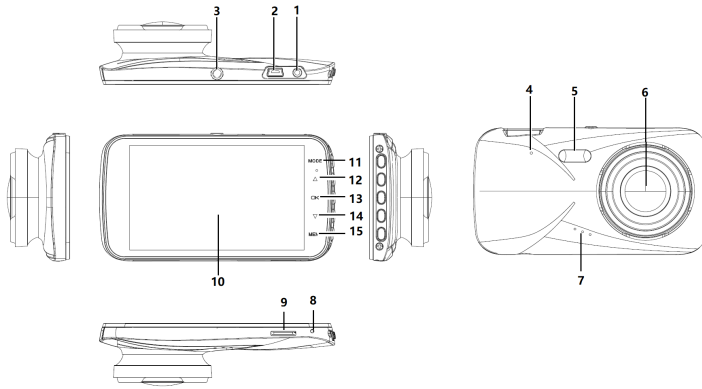

1. Rear Camera interface	6. Front Lens	11. Mode Key
2. Car Charger interface	7. Speaker	12. Up Key
3. Bracket Hole	8. Microphone	13. OK/Power Key
4. Reset	9. Card Slot	14. Down Key
5. LED Light	10. 4.0 Inch Screen	15. Menu Key



Installation Diagram

Installation of wiring diagram suggested below.

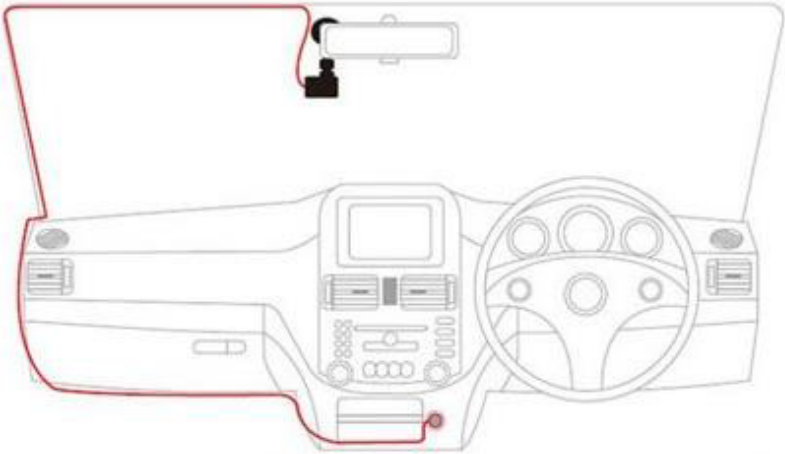

Installation Guide

1. Turn off your vehicle engine.
2. Insert the TF card into the recorder slot.

[Note] Please use the high-speed TF card (Class10 above), capacity of not less than 8G. TF card can support up to 32GB.

3. The recorder is fixed to the front windshield of the car.
4. The car charger into the car cigarette lighter.
5. Extension cable charging the recorder's USB connector and car charger is connected.

[Note] Reduces charging extension cord wiring can be laid along the edge of the windshield.

6. The rear camera is installed in the rear of the vehicle. Pay attention to the direction of installation. Wiring can be laid along the vehicle roof. After

the installation is complete you will plug into the recorder rear camera interface.

7. Adjust the lens position to ensure that the lens levels with the ground.

8. Start the engine and check if the machine has been installed correctly.

[Note] When the machine is properly installed, the system indicator lights will work; the machine starts to enter the recording state and the recording indicator light flashes. Remember to check if the display screen is normal. If not, please contact us.

WiFi Connection Instructions

The **Roadcam App** lets you control your camera remotely using a smartphone or tablet. Features include full camera control, live preview, photo playback and sharing of select content and more.

Steps to install APP on smart phone

A. Android system mobile phone

1. Open the "Google Play Store" search "Roadcam"
Or scan the QR Code to download and install.



B. IOS system Apple phone

1. Open the "Apple App Store" search "Roadcam"
Or scan the QR Code to download and install.



1. Enter the system setting to choose the WIFI, turn it on, the WIFI name and WIFI password will show on the camera screen.
2. In your smartphone's WiFi settings, connect to the camera WIFI name, Enter the Password.
3. Open the Roadcam on your smartphone.
4. The app will automatically start recording once the WiFi is connected successfully.
5. Press the red 'Video Recorder button' on the APP to stop recording, the APP will automatically switch to Playback mode, you can playback the video from 'Loop mode' or 'Emergency'.
 - 1) Short press the video to edit the video,
 - 2) Long press the video to download it to your cell phone or delete it.
6. Press the 'Record' on the APP to stop recording, then short press the 'Camera' to switch to photo mode.
Short press the 'Picture' to playback the photos, long press the photo to download it to your cell phone or delete it.
7. On the APP settings, you also can change the camera setting.
8. Short press the 'OK' key on the camera to disconnect the WiFi and then press the 'UP' or 'Down' key to 'Refresh' or turn off the WiFi.

Icons and Functions

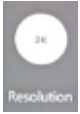

Video Resolution

Select the video resolution on your camera. Resolution is the height of the video in pixels. Higher resolution video settings require more memory card space than lower resolution settings. 2K+1080P, 1080P+2K

Default Setting: 2K+1080P



Loop Record

Select duration of recording length for the individual video files, the camera will fill the SD Card and then loop back to the beginning, overwriting the saved files (unless protected)

Default Setting: 1 Minutes



Time Lapse

off/1S/2S/3S; It is a shooting technology that can compress and shorten the longer of video recording. To a certain extent, it can monitor and protect the car all day and save the recorder memory storage.

Note: only can be used while use ACC cable.

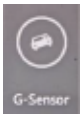

G-sensor

Turn Off or adjust the sensitivity (Low/Middle/High) of the G-Sensor to defect forces which will automatically protect the current recording in event of a collision. Default Setting: Off

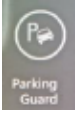

Parking Guard

Off/Low/Middle/High. When you open the parking guard in the off state, if the car has a slight vibration, the recorder will automatically start recording

Default Setting: Off

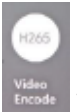

Video Encode

H.264/H.265; choose the video encode, relating with the recorded files size, H.265 save TF card storage RAM.

Default setting: H.264

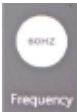

Frequency

You can set 50Hz/60Hz. This function works if has flashing or ripple on the video screen light, it will eliminate it.

Default setting: 60Hz

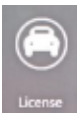

License

The camera has an option to program your car's license plate number into it, and have that display as an 'overlay' on the recorded video.

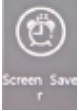

Screen Saver

Turn on the screen saver function, shut down the screen after a period of inactivity, with options of Off/1 Minute/3 Minutes. Press any button to re-activate the display.

Default Setting: Off



Boot sound

Turn on/off the Boot sound, Screen opening voice on/off

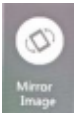

Mirror Image

Turn on to mirror the image of rear camera so that the image on the screen matches that of your rear-view mirror when reversing.

Default Setting: Off

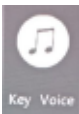

Key Voice

Turn on/off the Key Voice, key button operation voice on/off

Default Setting: On

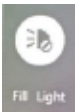

Fill Light

Turn ON/OFF/AUTO fill light, LED light will on/off/auto

Default Setting: Off

WDR (Wide Dynamic Range)

Adopt internationally advanced double (long & short) exposure techniques, reformat video images to be optimal. Images is commonly overexposed in the strong sunshine, and hardly to be taken in the dim light conditions, WDR capability gets the issue resolved. Turn this function on/off under menu settings.

Exposure

Now, the dash cam comes standard set to a +0.0 exposure, which is essentially baseline. This level of exposure will account for every day lighting scenarios, bright days, darker days, etc. The exposure and aperture both determine how much light is being allowed into the lens of the camera. So, on a regular, mild day, the standard factory setting will do just fine.

The only time you want to adjust your exposure is when there is too little light, or too much light in any given location. If it is dark outside, and your footage is coming out too dark, you can simply ramp up the exposure, and your camera will maximize the amount of light it absorbs. This trick will ensure that your night vision comes out clearer. Exposure can be adjusted under menu settings.

1. Power key

Function 1: Switch function

1. In the off state, press the power /OK button and hold for 3 seconds for the machine to start working automatically.
2. In the on state, press the power / OK button and hold for 3 seconds, the unit automatically shuts down and keep video files and user settings switch.

2. MODE key

Function 1: Mode key

Press OK to pause the video recording, short press the Mode key, the camera photograph/playback/video can be switched with each other. In camera mode, press OK to take photo. In playback mode, short press Menu to delete

or protect the file, press UP and Down to select the video/ photo for playback, short press OK to playback video. In video mode, press OK to start recording.

Function 2: Emergency locking function

When recording, if you want to protect the current video from being covered, short press mode key to start emergency locking function, then on the upper left corner of the screen, will appear a lock file icon which indicates that the current video is saved as a special file that cannot be recycled or covered by another video.

3. Up Key

Function 1: Page Up

Press to use the scroll function in the menu settings and playback modes.

Function 2: Camera switching function

When the reversing camera is connected to the dash cam, dual cameras display will automatically show on the screen. Under recording mode, short press **【Up】** button to switch between 4 types of display mode: Front camera only, Rear camera only, Picture in picture, split screen display

Function 3: Zoom In

Under camera mode, short press the Up button for the lens to zoom in.

Function 4: Rewind

In recovery mode, press the up key to rewind

4. OK key

Function 1: Enable / Disable recording function

In the video mode, press the Ok key to start recording and short press the Ok key again to stop recording.

Function 2: Take photo

In camera mode, press the Ok key once to take a picture

Function 3: File playback

In the file explorer mode, press the Ok key to play video

Function 4: Confirm

Press OK to pause the video recording, press the Menu key to enter the menu mode, press the up/down keys to navigate, press the Ok key to determine

5. Down key

Function 1: Page down function

In the menu settings and playback mode for the next page function

Function 2: Close Recording

In the video mode, press [Down] key to turn off the audio recording function, the screen above the microphone icon becomes ban, indicating it had closed the audio recording function. Press again to turn on the audio recording. The audio recording icon will be displayed.

Function 3: Fast forward

In Playback mode, press [Down] key to fast forward

6. MENU key

Function 1: Video menu

Press OK to pause the video recording, press the [Menu key] to enter the main menu function setting table. Press the [up/down] key to select the option to be set. Press [OK] to confirm. After setting, press the Menu key until you exit the menu setup function. (Menu setting methods are the same as in the video mode, camera mode and playback mode)

Function 2: Open Led light, Long Press [Menu key] to turn on Led light, long-press [Menu key] to turn off Led light again

Reversing camera installation

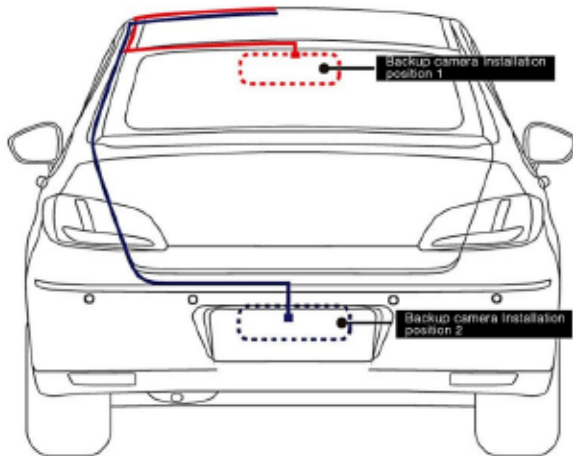

1. Connect the reversing camera to the car number plate and adjust the angle of the lens.
2. Connect the red wire to the positive of the reversing light (the reversing image will show on the screen automatically when the car is on reverse).
3. Connect the black wire to the negative of the reversing light.
4. Connect the video cable to the “Reversing camera input” of the dash cam (this will feed the video image from the camera to the dash cam, and also provide power to the camera when the car is on forward gear).
5. In the reverse image state, use the [Up] / [Down] keys to adjust the position of the reference line. After that, the adjustment will be saved.

Features

1. Use automatic recording function

Start the car engine. The recorder automatically starts to open the recording function, the charge indicator lights and video light is blinking. After switching off the engine, the recorder automatically saves the contents of the recorded video and shut down. Recorded video segment is stored in the TF card. When the memory is full, the recorder will overwrite the earlier recorded image.

Note:

- a. Recording time cycle can be selected in the menu settings ranges from 1 minute / 2 minutes / 3 minutes / 5 minutes / 10 minutes / OFF.
- b. Front, rear camera and video camera are recorded separately to the "MOVIE" and "PHOTO" folder.

2. Use manual recording functions

Press the [OK] key, the recorder automatically starts. Video recording indicator lights up and blinks. To shut down the power button press [OK] for 3 seconds, the recorder will automatically save the record again and shut down.

3. Take photo function

Press OK to pause the video recording, short press the [Mode] button to enter the camera mode. The upper left corner of the display is converted to a camera. Press [OK] to take pictures. To switch back to recording mode, press the [Mode] key twice.

4. Motion detection function

Press OK to pause the video recording, press [MENU] key to enter menu selection mode to turn on motion detection. When the lens senses a moving object, the state of the machine will change into camera and when the lens does not detect any moving objects for 30 seconds, the system will stop recording. To exit the motion detection mode, long press on the turn button for 3 seconds to exit the motion detection mode.

5. G-sensor function

The unit features an impact sensor (G-sensor). If a serious vehicle collision, the recorder will lock the first 10 seconds, and 20 seconds after the accident occurred and save it as a special image, the monitor will display a lock icon in the lower left. Locked images will not be overwritten.

【prompt】

a. Locked video file name will show “EVE”.

b. G sensor can be turned on under Menu [G-sensor], you can select the desired G sensor sensitivity High, Medium, Low or Off, according to the actual need. The higher the sensitivity, the more videos will be locked and will not be erased during loop recording, therefore, we suggest you to select Medium sensitivity.

Alternatively, Press Mode while the video is recording to lock the files.

6. A key lock function

The machine has a key lock feature that will retain an image without being locked loop overwritten. In the video mode, short press down, the recorder will lock the first 10 seconds, and 20 seconds after the accident occurred and save it as a special image.

7. Date and time settings

Press OK to pause the video recording, short press [Menu] key to enter the system setup menu, press the down arrow key [Up] / [Down] keys to move the cursor to set the date options. Press [MODE] to enter the menu settings.

[Note]

In order to efficiently record the date and time of the traffic accidents forensics before using the machine, please set the correct date and time.

8. A mute button function

In working condition, short press the [Down] key, the screen changes to prohibit the bottom left of the microphone icon, indicating that audio

recording has been turned off. The recorder only records the image without a sound. Short press the [Down] button below the microphone and the screen changes to the record icon to indicate resume recording.

[Note] settings are saved automatically, without having to re-boot after the mute function.

9. U-disk mode

The recorder is connected via a data line computer USB port. The screen displays the disk and camera, the two selectable modes. Press up key [Up] / [Down] keys to select the Disk option. Then press [OK] to enter the U disk mode.

10. Shooting File Playback

In Boot state, short press [MODE] key to switch to playback mode. Press the [Up] / [Down] keys to find the file you want to play back and press [OK] to play. To exit playback mode, short press [MODE] key.

11. Parking Monitor

When you open the parking monitoring in the off state, if the car has a slight vibration, the recorder will automatically start recording for 30 sec and shut down.

[Note] This feature requires hardware support.

12. WDR (Wide Dynamic Range)

Adopt internationally advanced double (long & short) exposure techniques, reformat video images to be optimal. Images is commonly overexposed in the strong sunshine, and hardly to be taken in the dim light conditions, WDR capability gets the issue resolved. Turn this function on/off under menu settings.

13. Exposure

Now, the dash cam comes standard set to a +0.0 exposure, which is essentially baseline. This level of exposure will account for every day lighting

scenarios, bright days, darker days, etc. The exposure and aperture both determine how much light is being allowed into the lens of the camera. So, on a regular, mild day, the standard factory setting will do just fine.

The only time you want to adjust your exposure is when there is too little light, or too much light in any given location. If it is dark outside, and your footage is coming out too dark, you can simply ramp up the exposure, and your camera will maximize the amount of light it absorbs. This trick will ensure that your night vision comes out clearer. Exposure can be adjusted under menu settings.

14. Screen saver

The screen will turn off by itself after 1min, 3mins or 5mins if this is turned on, but the dash cam is still recording at the background. If you do not want the screen to turn off by itself, please select OFF.

15. Rear camera mirroring

Enable rear camera video recording, turn on/off under menu settings.

Product Specifications

Display	4.0-inch IPS Screen 960*540
Front camera	Chipset: Hisilicon HI3556V200 Sensor: Sony IMX335
Rear camera	AHD 1080P rear camera
Visual angle	170 degrees
Minimum illumination	1Lux
Video mode	Loop video / Motion detection
Video format	MP4
Video coding mode	H.265
Video resolution	2560 x 1440p, 1920 x 1080p, 1440 x 1080p
Camera Photo Resolution	5000 x 3750, 4032 x 3024, 3648 x 2736, 3264 x 2448, 2592 x 1944
Video Output	N/A
Seamless video	Yes
Boot automatic recording	Supported
Gravity Sensing	When car crash, it will emergency save videos, not to be deleted
Manual lock	Video, short press mode key, to lock the current file, not deleted
Languages	English, French, Spanish, Portuguese, German, Italian, Chinese, Russian, Japanese, Korean, Thai
Video Cyclic Record time	Off / 1 min / 2mins / 3mins /5mins /10mins
Sound recording	Built in microphone, recording can be selected to close / open
Version number	Display product model, software version and update time
Night Vision	2 white light lamps
Memory card	TF Card
Memory card capacity	8GB--64GB
USB interface	USB2.0 Mini5Pin
Operating system	Windows 2000, XP Windows, Windows 7, etc.
Battery	Super Capacitor
Power waste	Double recorded video MAH 500-700
Power Supply	Vehicle mounted power 5V/2A
Storage temperature	-10 C ~ 70 C
Operating temperature	-10 C ~ 60 C

Instructions to use:

- For best result in using Dash Camera, we definitely recommend to keep it plug-in into the car cigarette charger. This will allow you to use or record for a longer period of time. Dash Camera uses a lot of battery due to G Sensor system of the camera.
- To watch recorded video clips, please remove SD card from Dash Camera and connect it to your computer or laptop. This will allow you to watch all videos recorded.
- Please peel off the protective film on the screen before use.
- If you would like to use parking monitor function, please purchase compatible hard wire kit from our store.

Common Troubleshooting

Dash cam is not recording properly, please check:

1. Format the SD card and try again.
2. Change to another SD card and try again.
3. Reset to factory settings under menu.

Under normal operating conditions, please refer to the solutions:

Unable to boot - Check the recorder and car charger if properly connected, if you manually turned on, check the battery level if it is too low needs recharging. Press RESET button to restore to the factory settings.

When the camera automatically stops recording, or do not cycle the camera - Due to the huge high-definition video data, it is possible because the memory card reader could not keep pace. Please use the high-speed TF card, such as Class10 high-speed card.

If the loop recording is not working, it is also possible that gravity sensor is open, the files on memory card are all locked. Close the gravity sensor setting, and the format the memory card.

Each time the camera settings cycle is not the same - Check if motion detection function is on, because the camera motion detection state length of time, depending on the screen if there is no movement.

Video recorded is unclear - Please clean the lens before shooting the surface, keep the lens clean.

Bad video effect - Camera and lightning conditions will affect the video quality; adjust the position of the dash cam for best result.

Images have streaks interference - This is due to the wrong setting "light frequency" produced under the fluorescent lights, the domestic flat rate "50HZ" when the machine briefly press the "RESET" the reset button to restore restart.